

**PV 411A пневмо-гидравлическая  
ручная помпа**

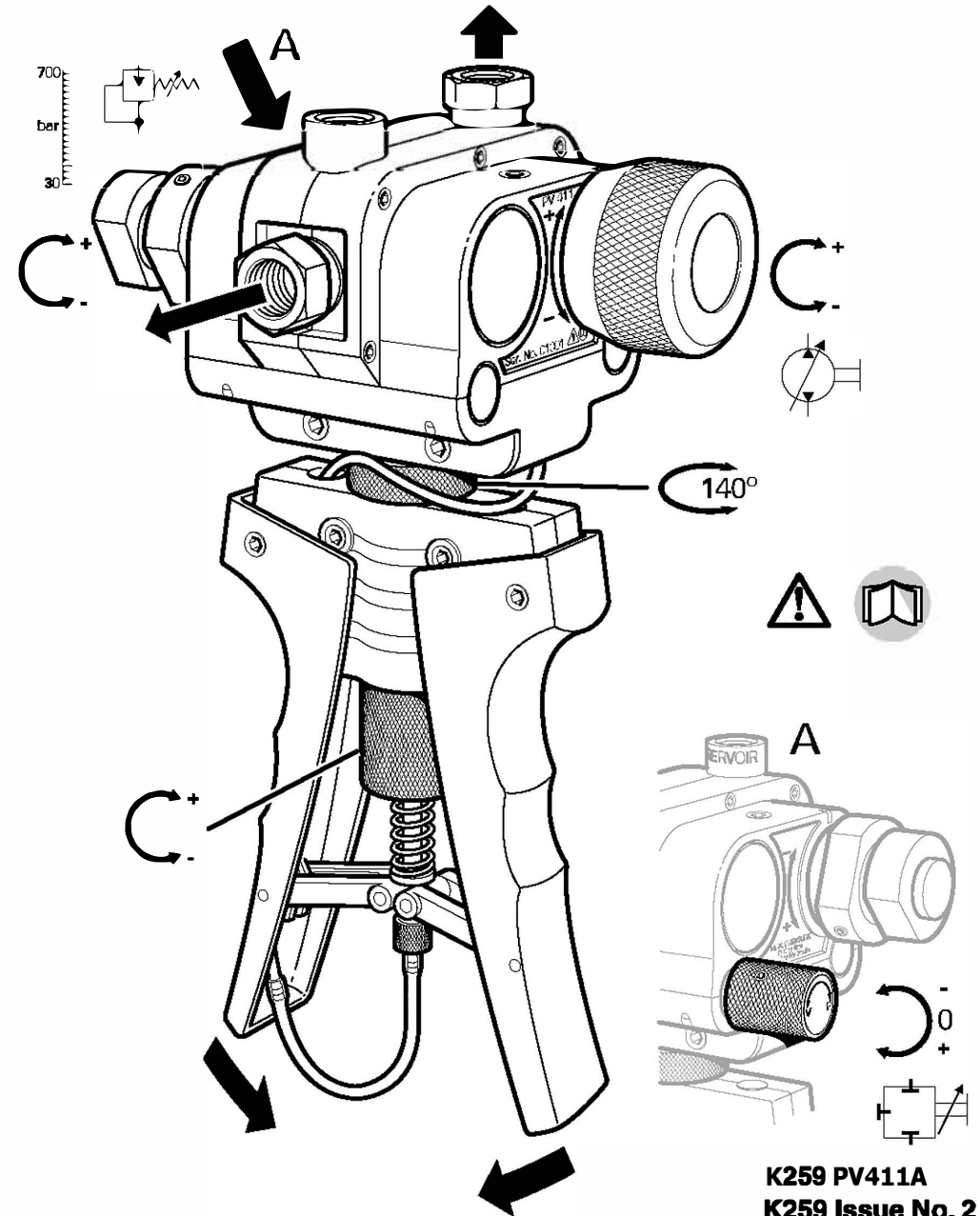

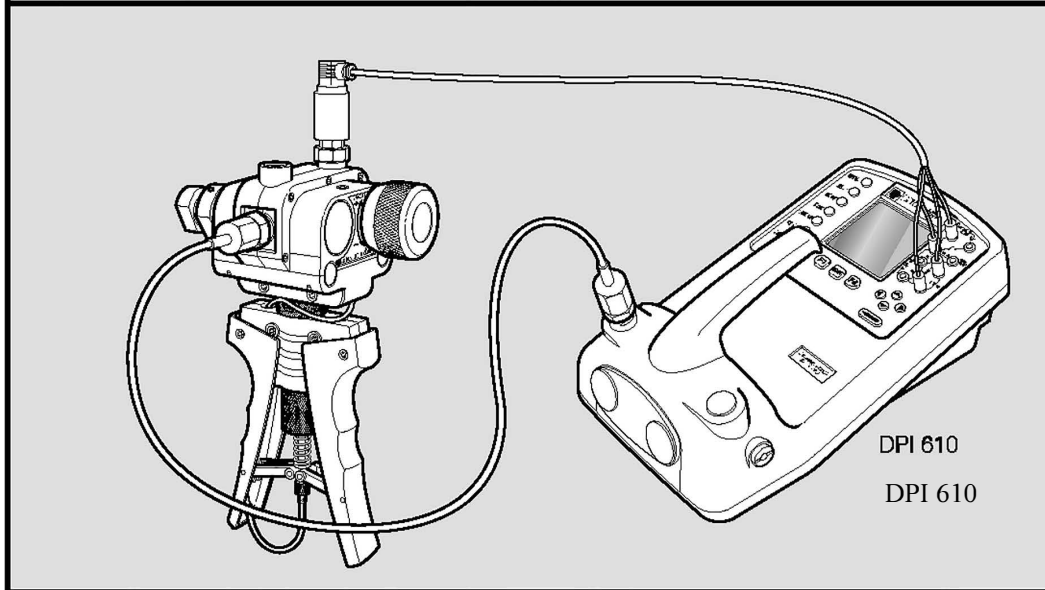

1/4NPT

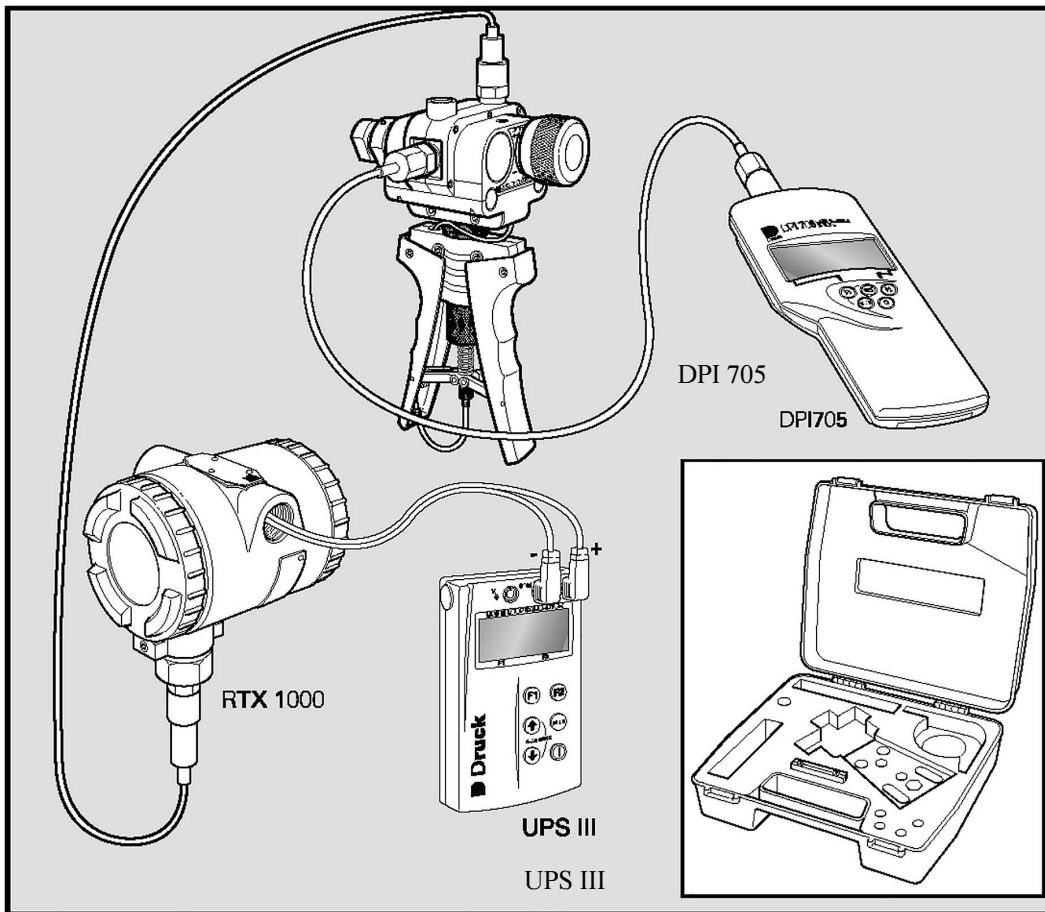
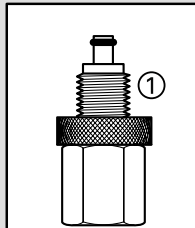
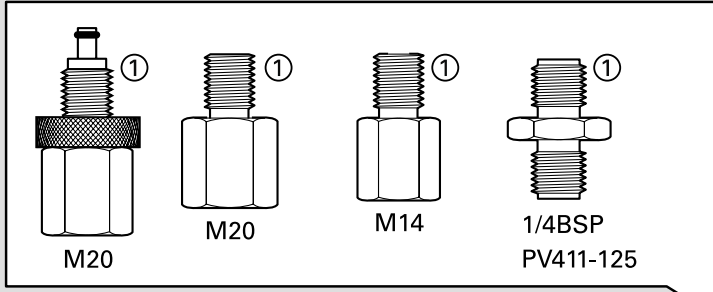

PV411-120

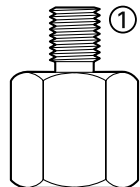

1/4NPT

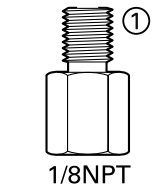

1/8NPT

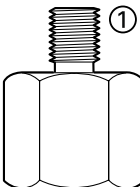

3/8NPT

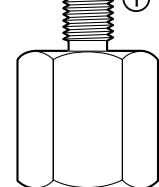

1/2NPT

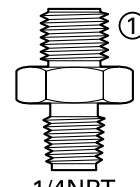

1/4NPT

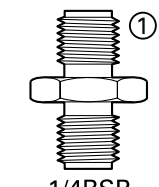

1/4BSP

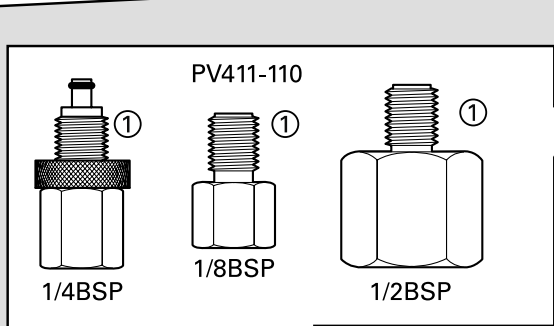

PV411-110

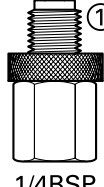

1/4BSP

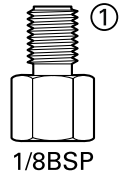

1/8BSP

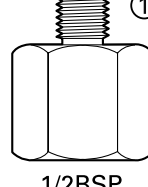

1/2BSP



3/8BSP

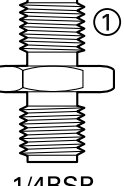

1/4BSP

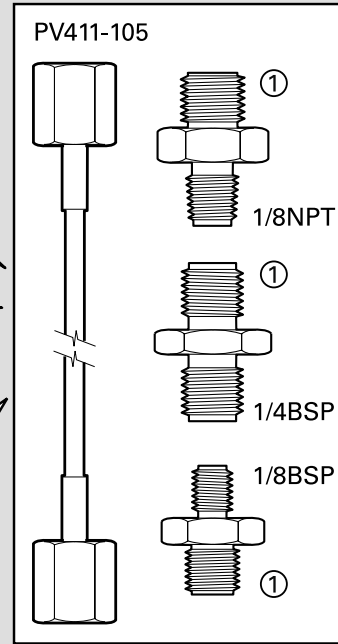

PV411-105

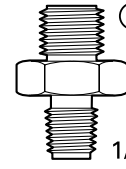

1/8NPT

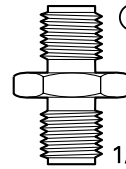

1/4BSP

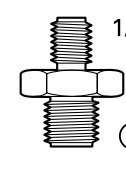

1/8BSP

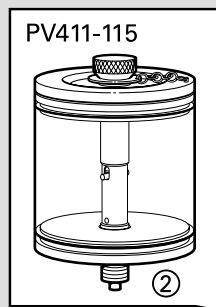

PV411-115

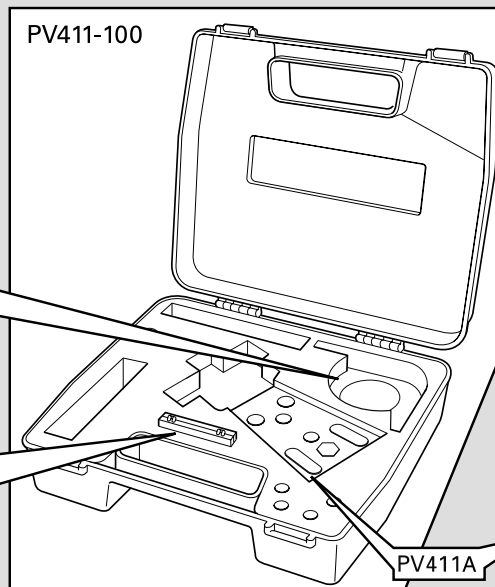

PV411-100

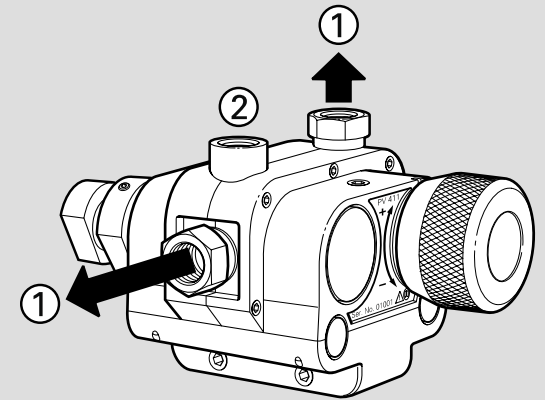

1

2

1

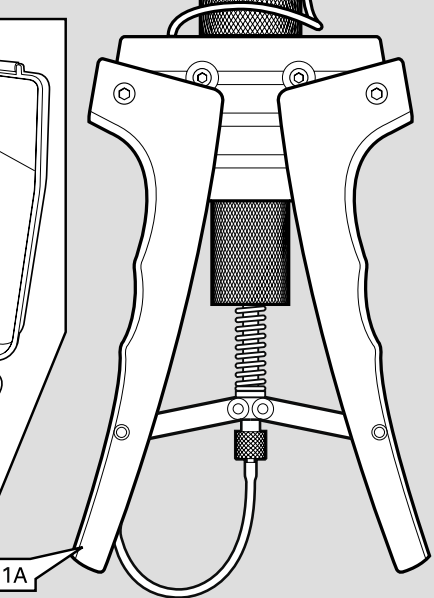
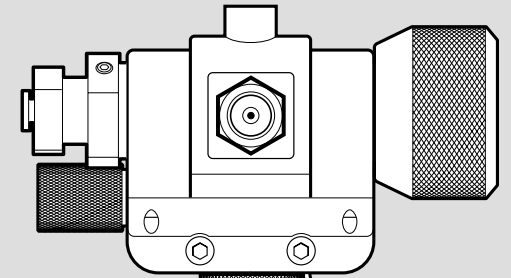

**PV411-P =**  
 PV411A +  
 PV411-100 +  
 PV411-105 +  
 PV411-110 +  
 PV411-130 +

**PV411-HP =**  
 PV411-P +  
 PV411-115

e-mail: [sales@druck.com](mailto:sales@druck.com)  
 Internet: [www.druck.com](http://www.druck.com)

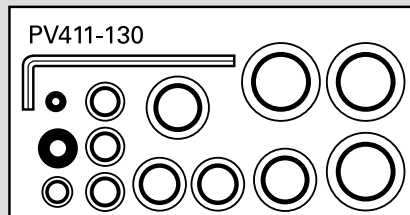

PV411-130