

N 87 SERIES EXPLOSION PROOF PUMPS

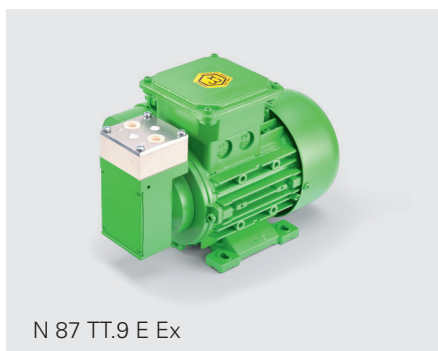

N 87 TT.9 E Ex

ADVANTAGES

- High chemical resistance
- Robust design
- Copes well with vapor and condensation
- High level of performance in a compact size
- Excellent price/performance ratio
- Motor approved in accordance with ATEX/IECEX
- High level of gas tightness: approx. 6×10^{-3} mbar x l/s

POSSIBLE AREAS OF USE

- Environmental monitoring – especially in potentially explosive fields
- Process industry
- Chemical industry

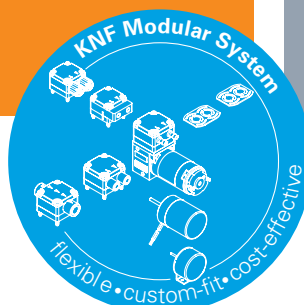

Please visit our website
www.knf.com
to get more information

PERFORMANCE DATA					
Series model	N 87				
Material design	TT.9 E Ex				
Pump head	PVDF				
Diaphragm	PTFE-coated				
Valves	FFPM				
Flow rate at atm. pressure (l/min)	7.5				
Ultimate vacuum (mbar abs.)	140				
Max. operating pressure (bar rel./psig)	1.5/21.8				
Permissible ambient temperature (°C)	+5 ... +40				
Permissible media temperature (°C)	+5 ... +40				
Weight (kg/lbs)	6.7/14.8				
ELECTRICAL DATA					
Voltage (V)	230	220	115	110	100
Motor	Capacitor motor				
Protection class motor	IP 66				
Protection class pump	IP 55				
Frequency (Hz)	50/60				
Power P ₂ (W)	60	120			
I _N (A)	0.6/0.7	1.09/1.18	2.18/2.12	2.18/2.10	2.28/2.26
Explosion protection pump parts	Ex II 2G Ex h IIB+H2 T4 Gb				
Explosion protection capacitor motor	Ex II 2G Ex dbeb IIC T4				

N 87 TT.9 E EX

PERFORMANCE DATA

Series model	Flow rate at atm. pressure (l/min) ¹⁾	Max. operating pressure (bar rel./psig)	Ultimate vacuum (mbar abs.)
N 87 TT.9 E Ex	7.5	1.5/21.8	140

¹⁾ Liter at STP

N 87 TT.9 E EX

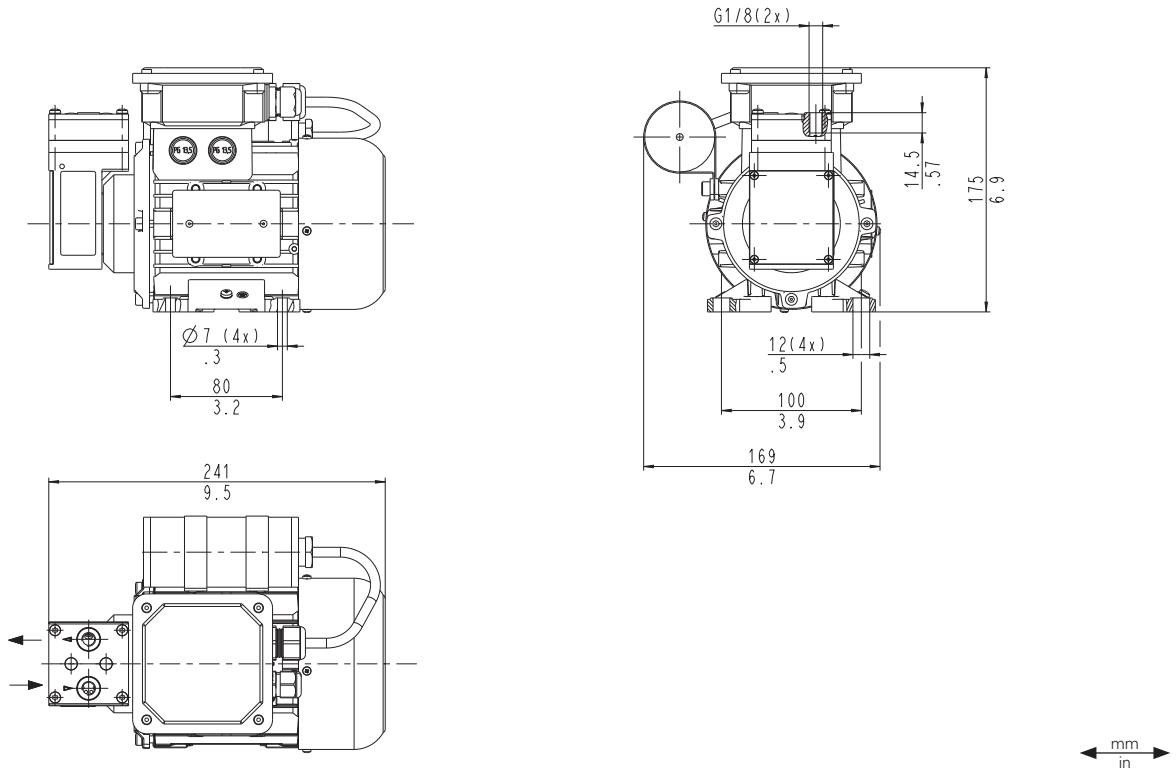

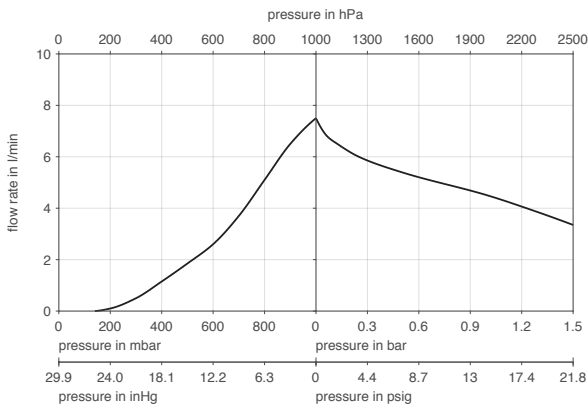

N 87 TT.9 E EX

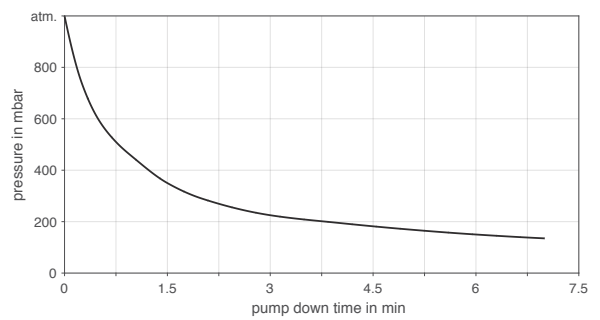

N 87 TT.9 E EX | PUMP DOWN TIME FOR 5 LITER VESSEL



ACCESSORIES

Description	Illustration	Part No.	Details
Hose connector for tube ID 6		123363	PVDF, G1/8
Inserted screw connection ID 6		014049	PVDF, G1/8

SPARE PARTS:

Description	Part No.
Spare parts kit N 87 TT.9 E Ex (1x valve plate, 1x diaphragm, 2x screw caps)	322292

The performance values for the series models shown on this data sheet were determined under test conditions. The actual performance values may differ and depend in particular on the usage conditions and therefore on the specific application, on the parameters of the components involved in the user's system and on any technical modifications carried out which deviate from the standard configuration or the as delivered condition.

If individual designs have been created for specific customers on the basis of series models, other technical performance data may apply. Before operation begins, the relevant operating instructions and/or assembly or installation instructions should be read and the safety information contained in these instructions should be noted. KNF reserves the right to make changes to the product and the associated documentation without prior notice to the customer.



www.knf.com

YOUR LOCAL PARTNER AROUND THE WORLD

KNF SALES ORGANIZATION

Australia KNF Regional Office
Moreland West VIC 3055
Tel. +61 3 9386 4959
info@knf.com.au
www.knf.com.au

Benelux Netherlands KNF Verder B.V.
3451 GG Vleuten
Tel. +31 30 677 92 40
info@knf-verder.nl
www.knf-verder.nl

Benelux Belgium and Luxemburg
KNF Verder N.V.
2630 Aartselaar
Tel. +32 3 871 96 24
info@knf.be
www.knf.be

China KNF Technology (Shanghai) Co., Ltd.
Shanghai 201203
Tel. +86 21 5109 9695
info@knf.com.cn
www.knf.com.cn

France KNF Neuberger SAS
68128 Village-Neuf
Tel. +33 389 70 35 00
info@knf.fr
www.knf.fr

Germany KNF Neuberger GmbH
79112 Freiburg
Tel. +49 7664 5909 0
info@knf.de
www.knf.de

India KNF Pumps + Systems (India) Pvt. Ltd.
Hinjewadi Pune 411 057
Tel. +91 20 640 13 923
info@knfpumps.in
www.knfpumps.in

Italy KNF Italia S.r.l.
20063 Cernusco s. Naviglio (MI)
Tel. +39 02 929 04 91
info@knf.it
www.knf.it

Japan KNF Japan Co. Ltd.
Tokyo 104-0033
Tel. +81 3 3551 7931
info@knf.co.jp
www.knf.co.jp

Korea KNF Neuberger Ltd.
135-502 Seoul
Tel. +82 2 959 0255
knf@knfkorea.com
www.knfkorea.com

Latin America KNF Regional Office
Tel. +1 609 649 1010
gb@knf.com
www.knf.com/es

Morocco, Tunisia, Algeria
KNF Neuberger SAS
68128 Village-Neuf
Tel. +33 389 70 35 00
info@knf.fr
www.knf.fr

Singapore KNF Regional Office
Tel. +65 9722 1994
info@knf.com.sg
www.knf.com.sg

Sweden, Finland, Denmark, Norway
KNF Neuberger AB
117 43 Stockholm
Tel. +46 8 744 51 13
info@knf.se
www.knf.se

Switzerland KNF Neuberger AG
8362 Balzerswil
Tel. +41 71 973 99 30
knf@knf.ch
www.knf.ch

UK, Ireland KNF Neuberger U.K., Ltd.
Witney, Oxfordshire OX28 4FA
Tel. +44 1993 77 83 73
info@knf.co.uk
www.knf.co.uk

USA, Canada KNF Neuberger, Inc.
Trenton, NJ 08691-1810
Tel. +1 609 890 8600
knfusa@knf.com
www.knfusa.com

KNF PRODUCT CENTERS

Gas Pumps KNF Neuberger GmbH
DE-79112 Freiburg
info@knf.de
www.knf.de

Micro Gas Pumps KNF Micro AG
CH-6260 Reiden
info@knf-micro.ch
www.knf-micro.ch

Liquid Pumps KNF Flodos AG
CH-6210 Sursee
info@knf-flodos.ch
www.knf-flodos.ch