

# NMP05 SERIES MICRO DIAPHRAGM GAS PUMPS

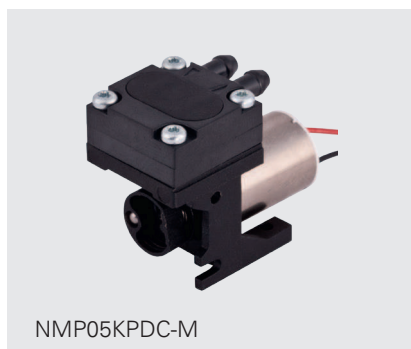

NMP05KPDC-S



NMP05KPDC-M



NMP05KPDC-L

## ADVANTAGES

- Customizing available
- Tested to customers specs
- High performance to size, efficiency and weight ratio
- Excellent reliability/durability
- Speed controllable
- Low sound level
- Long service life
- Uncontaminated transfer
- Maintenance-free
- High chemical resistance
- Can be installed in any position

## POSSIBLE AREAS OF USE

- Medical devices
- Analytical equipment
- Emission measurement
- Reprographic
- Degassing
- Safety/Security
- Portable devices

Please visit our website  
[www.knf.com](http://www.knf.com)  
to get more information.

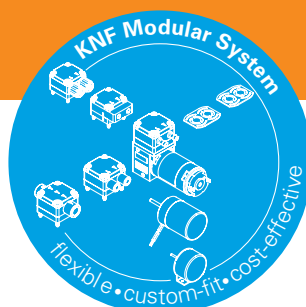

## PERFORMANCE DATA

Series Model	NMP05					
Material design	KPDC-S		KPDC-M		KPDC-L	KPDC-B
Pump head	PPS					
Diaphragm	EPDM					
Valves	EPDM					
Flow rate at atm. pressure (l/min)	0.25	0.4	0.4	0.3	0.45	0.4
Ultimate vacuum (mbar abs.)	600	600	600	600	550	450
Ultimate pressure (bar rel)	0.35	0.4	0.3	0.3	0.4	0.5
Permissible media and ambient temperature (°C/°F)	+5° C to +40° C / 41° F to 104° F (-20° C to +60° C / -4° F to 140° F on request)					
Weight (g/oz)	15/0.53	18/0.63	17/0.60	20/0.71	26/0.92	22/0.78

## ELECTRICAL DATA

Voltage (V)	3	5	2.5	6	6	6
Motor	DC		DC		DC	Brushless DC
I <sub>max</sub> (A)	0.12	0.14	0.11	0.055	0.09	0.12

# NMP05KPDC-S

## PERFORMANCE DATA

Series model	Flow rate at atm. pressure (l/min)	Max. operating pressure (bar rel)	Ultimate vacuum (mbar abs.)
NMP05KPDC-S 3V	0.25	0.35	600
NMP05KPDC-S 5V	0.4	0.4	600

## NMP05KPDC-S

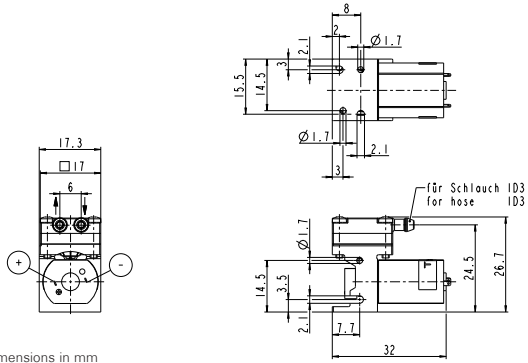

Dimensions in mm

# NMP05KPDC-M

## PERFORMANCE DATA

Series model	Flow rate at atm. pressure (l/min)	Max. operating pressure (bar rel)	Ultimate vacuum (mbar abs.)
NMP05KPDC-M 2.5V	0.4	0.3	600
NMP05KPDC-M 6V	0.3	0.3	600

## NMP05KPDC-M

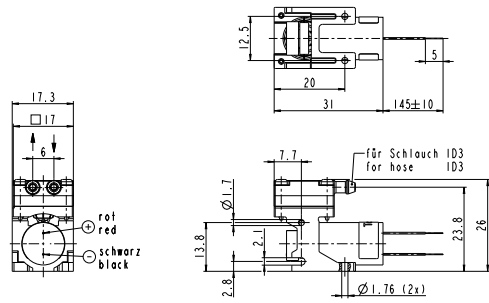

Dimensions in mm

## NMP05KPDC-S 3V FLOW CURVE

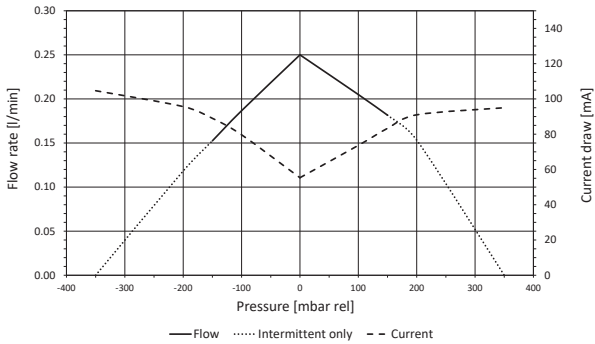

## NMP05KPDC-M 2.5V FLOW CURVE

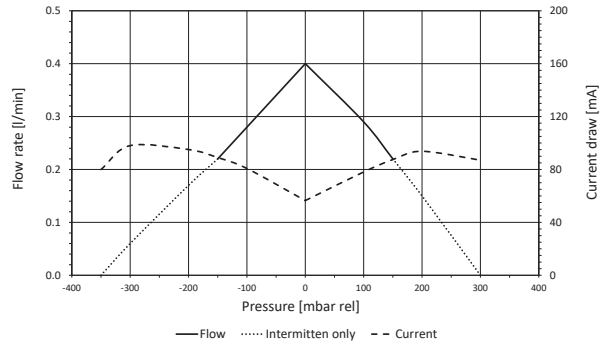

## NMP05KPDC-S 5V FLOW CURVE

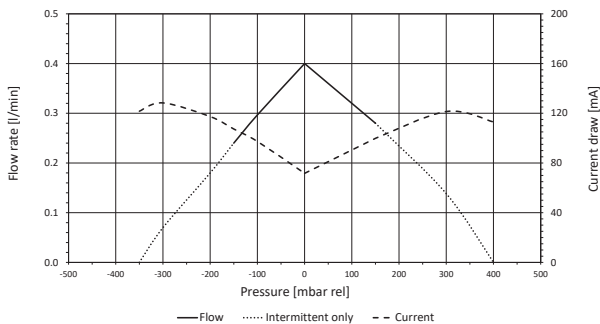

## NMP05KPDC-M 6V FLOW CURVE

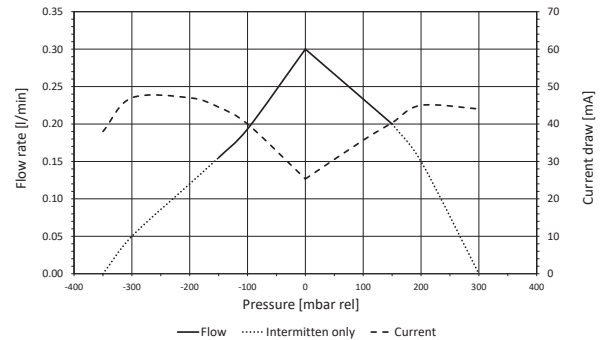

# NMP05KPDC-L

## PERFORMANCE DATA

Series model	Flow rate at atm. pressure (l/min)	Max. operating pressure (bar rel)	Ultimate vacuum (mbar abs.)
NMP05KPDC-L 6V	0.45	0.4	550

## NMP05KPDC-L

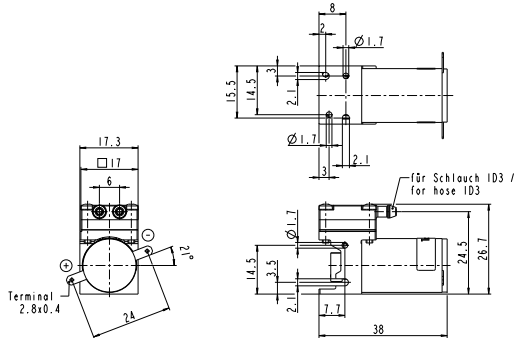

Dimensions in mm

# NMP05KPDC-B

## PERFORMANCE DATA

Series model	Flow rate at atm. pressure (l/min)	Max. operating pressure (bar rel)	Ultimate vacuum (mbar abs.)
NMP05KPDC-B 6V	0.4	0.5	450

## NMP05KPDC-B

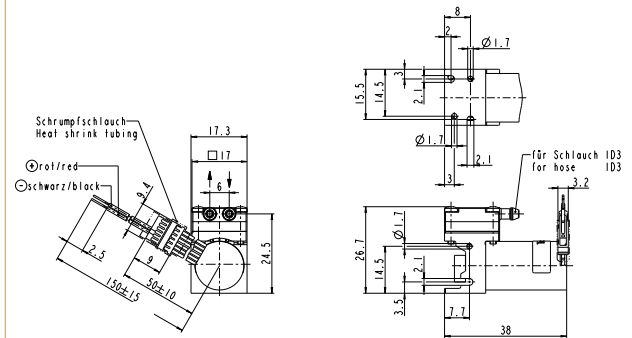

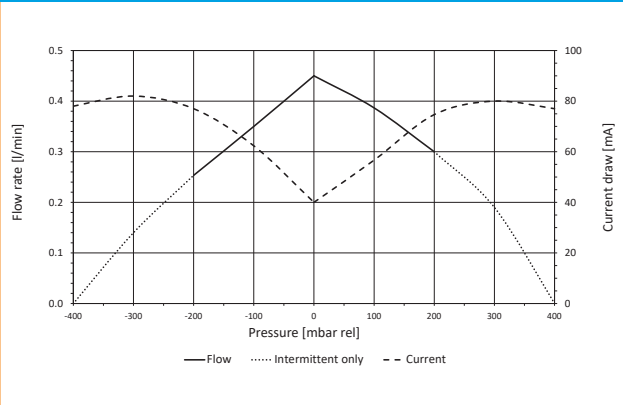

Dimensions in mm

## NMP05KPDC-L 6V FLOW CURVE

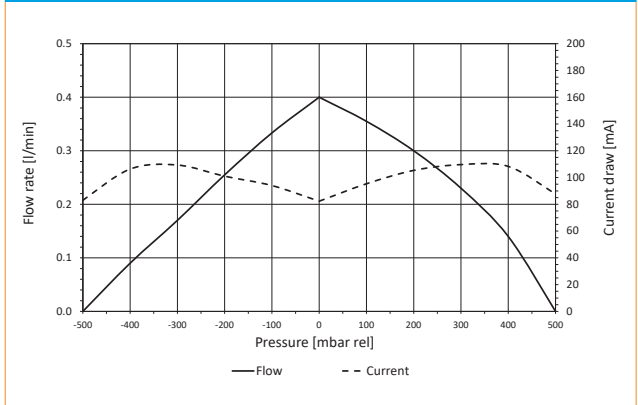

## NMP05KPDC-B 6V FLOW CURVE



OPTIONS			
Description	Illustration	Part No.	Details
Motors		On request	Other motors and voltages on request.
Eccentric		On request	Different eccentricities on request.

The performance values for the series models shown on this data sheet were determined under test conditions. The actual performance values may differ and depend in particular on the usage conditions and therefore on the specific application, on the parameters of the components involved in the user's system and on any technical modifications carried out which deviate from the standard configuration or the as delivered condition.

If individual designs have been created for specific customers on the basis of series models, other technical performance data may apply. Before operation begins, the relevant operating instructions and/or assembly or installation instructions should be read and the safety information contained in these instructions should be noted. KNF reserves the right to make changes to the product and the associated documentation without prior notice to the customer.



[www.knf.com](http://www.knf.com)

# YOUR LOCAL PARTNER AROUND THE WORLD

## KNF SALES ORGANIZATION

**Australia** KNF Regional Office  
Moreland West VIC 3055  
Tel. +61 3 9386 4959  
info@knf.com.au  
www.knf.com.au

**Benelux Netherlands** KNF Verder B.V.  
3451 GG Vleuten  
Tel. +31 30 677 92 40  
info@knf-verder.nl  
www.knf-verder.nl

**Benelux Belgium and Luxemburg**  
KNF Verder N.V.  
2630 Aartselaar  
Tel. +32 3 871 96 24  
info@knf.be  
www.knf.be

**China** KNF Technology (Shanghai) Co., Ltd.  
Shanghai 201203  
Tel. +86 21 5109 9695  
info@knf.com.cn  
www.knf.com.cn

**France** KNF Neuberger SAS  
68128 Village-Neuf  
Tel. +33 389 70 35 00  
info@knf.fr  
www.knf.fr

**Germany** KNF Neuberger GmbH  
79112 Freiburg  
Tel. +49 7664 5909 0  
info@knf.de  
www.knf.de

**India** KNF Pumps + Systems (India) Pvt. Ltd.  
Hinjewadi Pune 411 057  
Tel. +91 20 640 13 923  
info@knfpumps.in  
www.knfpumps.in

**Italy** KNF Italia S.r.l.  
20063 Cernusco s. Naviglio (MI)  
Tel. +39 02 929 04 91  
info@knf.it  
www.knf.it

**Japan** KNF Japan Co. Ltd.  
Tokyo 104-0033  
Tel. +81 3 3551 7931  
info@knf.co.jp  
www.knf.co.jp

**Korea** KNF Neuberger Ltd.  
135-502 Seoul  
Tel. +82 2 959 0255  
knf@knfkorea.com  
www.knfkorea.com

**Latin America** KNF Regional Office  
Tel. +1 609 649 1010  
gb@knf.com  
www.knf.com/es

**Morocco, Tunisia, Algeria**  
KNF Neuberger SAS  
68128 Village-Neuf  
Tel. +33 389 70 35 00  
info@knf.fr  
www.knf.fr

**Singapore** KNF Regional Office  
Tel. +65 9722 1994  
info@knf.com.sg  
www.knf.com.sg

**Sweden, Finland, Denmark, Norway**  
KNF Neuberger AB  
117 43 Stockholm  
Tel. +46 8 744 51 13  
info@knf.se  
www.knf.se

**Switzerland** KNF Neuberger AG  
8362 Balzerswil  
Tel. +41 71 973 99 30  
knf@knf.ch  
www.knf.ch

**UK, Ireland** KNF Neuberger U.K., Ltd.  
Witney, Oxfordshire OX28 4FA  
Tel. +44 1993 77 83 73  
info@knf.co.uk  
www.knf.co.uk

**USA, Canada** KNF Neuberger, Inc.  
Trenton, NJ 08691-1810  
Tel. +1 609 890 8600  
knfusa@knf.com  
www.knfusa.com

## KNF PRODUCT CENTERS

**Gas Pumps** KNF Neuberger GmbH  
DE-79112 Freiburg  
info@knf.de  
www.knf.de

**Micro Gas Pumps** KNF Micro AG  
CH-6260 Reiden  
info@knf-micro.ch  
www.knf-micro.ch

**Liquid Pumps** KNF Flodos AG  
CH-6210 Sursee  
info@knf-flodos.ch  
www.knf-flodos.ch